

VIVOSUN



VS LED Light USER MANUAL

Love what you grow™

Welcome to **VIVOSUN**

At Vivosun, quality craftsmanship and innovation are at the core of every product we create. Should you require further support or wish to share any suggestions, please don't hesitate to contact us.

PRODUCTS INCLUDED IN THIS MANUAL:

Product	Model	SKU
VS1000 LED 100W	VS1000	LED-100NJ
VS1000X2 LED 100W	VS1000X2	LED-100X2NJ
VS1500 LED 150W	VS1500	LED-150
VS2000 LED 200W	VS2000	LED-200
VS3000 LED 300W	VS3000	LED-300
VS4000 LED 400W	VS4000	LED-400J
VS1000E LED 100W	VS1000E	VS1000E
VS1000EX2 LED 100W	VS1000EX2	VS1000EX2

CONTENTS

Product Contents	1
Key Features	3
Specifications	4
Application	5
Installation	6
Warranty Information	9
Warning	10

PRODUCT CONTENTS

VS1000/VS1500/VS2000/VS3000/VS4000/VS1000X2

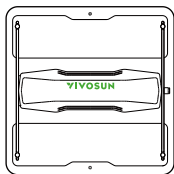

LED Light
x 1pc



Rope Hanger
x 2pcs



RJ11 3-Way
Cable Splitter
x 1pc

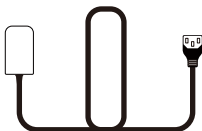

Power Cord
x 1pc

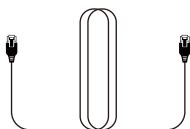

RJ11 Network Cable
x 2pcs

PRODUCT CONTENTS

VS1000E

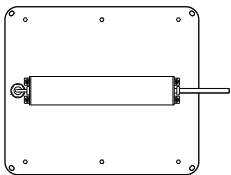

LED Light
x 1pc



Rope Hanger
x 2pcs

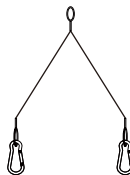

Wire Ropes
x 2pcs

VS1000EX2

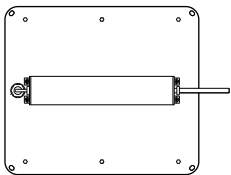

LED Light
x 2pcs



Rope Hanger
x 4pcs

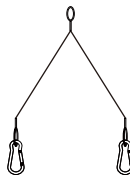

Wire Ropes
x 4pcs

KEY FEATURES

SAMSUNG LED DIODES

Powered by Samsung's high-efficiency horticulture diodes, emitting the perfect spectral output for plant growth.

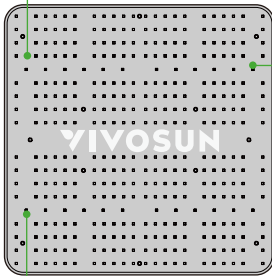

FULL SPECTRUM & FR

380-780nm of full spectrum coverage with 450nm, 660nm and 730nm for photosynthesis.

HIGH EFFICACY

Engineered with premium diodes and a robust power supply, this light delivers exceptional PPE of up to 2.7 $\mu\text{mol}/\text{J}$.

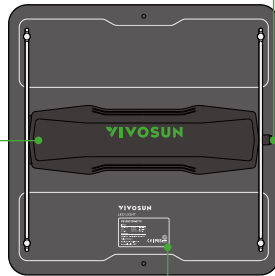

DAISY CHAINING

Control up to 20 lights with RJ11 serial connection.

DIMMABLE LED DRIVER

0-100% light dimming for different growth stages (except VS1000E).

CERTIFICATION

ETL, CE, FCC and IP65.

SPECIFICATIONS

	VS1000	VS1500	VS2000	VS3000	VS4000	VS1000E
LED Source	Samsung LM301D					Samsung LM281B+ pro
Spectrum	Full Spectrum: 380 – 780nm; rich 660nm and 730nm					
Input Voltage	120-277V					
Frequency	50-60Hz					
Power Factor	>0.9					
Input Power	100W	150W	200W	300W	400W	100W
Dimensions(L)	11.8"/30cm	14.2"/36cm	23.5"/60cm	19.7"/50cm	23.5"/60cm	11.8"/30cm
Dimensions(W)	11.8"/30cm	14.2"/36cm	11.8"/30cm	19.7"/50cm	23.5"/60cm	10.2"/26cm
Dimensions(H)	2.36"/6cm	2.95"/7.5cm	2.95"/7.5cm	3.23"/8.2cm	3.23"/8.2cm	1.69"/4.3cm
Weight	3.22 lbs. /1.46kg	5.42 lbs. /2.46kg	9.03 lbs. /4.1kg	10.93 lbs. /4.96kg	17.46 lbs. /7.92kg	2.98 lbs. /1.35kg
Dimming	25%/50%/75%/100%/OFF/EXT					N/A
Lifespan	L90>50,000 hours					
Certifications	ETL, CE, FCC, and IP65					
Warranty	5-Year Standard Warranty					

SPECIFICATIONS

SPECTRUM

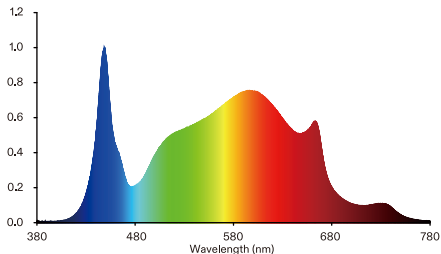

APPLICATION

SUGGESTED HANGING DISTANCE & LIGHTING TIME

Stage	Distance		Time
	Inch (In.)	Centimeter (cm.)	
Germination	24-30	61-76	18 Hours ON
Seeding	24-30	61-76	16 Hours ON
Veg	18-24	46-61	18 Hours ON
Flower	12-18	30-46	12 Hours ON

Set the LED power on high and place the light further away from your plants to cover a wider area, or set the LED at a lower power and place the light closer to your plants for less coverage but higher energy efficiency.

INSTALLATION

INSTALLATION OPTIONS (VS1000/VS1500/VS2000/VS3000/VS4000/VS1000X2)

1. Pass the rope hangers through the LED's hooks, and then fix the other end of the rope hangers to the ceiling.

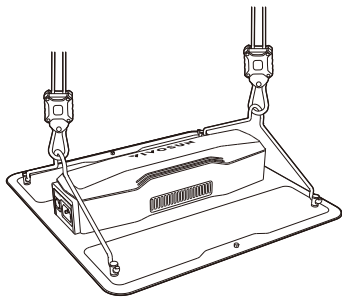

2. Remove the hooks from the LEDs, then fit them onto the ceiling bracket before installing them back onto the LED.

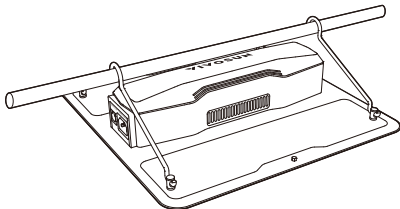

INSTALLATION

INSTALLATION OPTIONS (VS1000E/VS1000EX2)

1. Pass the rope hangers through the LED's hooks, and then fix the other end of the rope hangers to the ceiling.

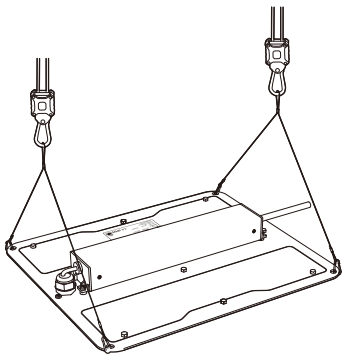

INSTALLATION

DAISY CHAININ

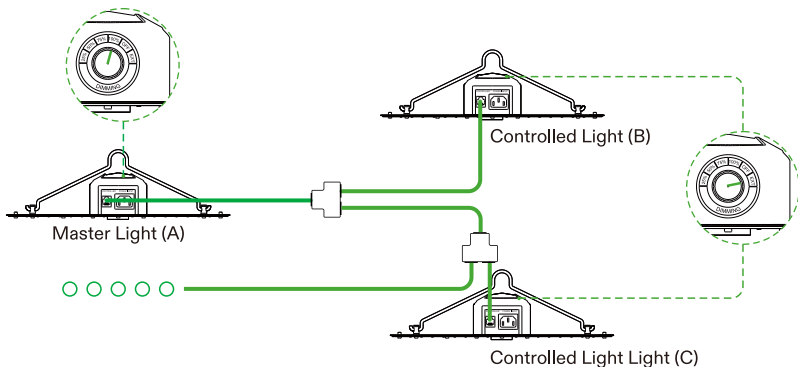

Choose a light as the Master Light (A) and use the RJ11 cables and cable splitter to connect other lights (B, C) as the Controlled Lights as shown above. Turn the dimming knob to "EXT" on the Controlled Light (B, C) to allow them to be controlled by the Master Light (A). A Master Light can control up to 20 lights.

Note: Ensure all the controlled lights are turned to "EXT" and functioning normally. If connected to a timer, ensure the total power of all the lights (including the master light and controlled lights) conform to the rated power of the timer.

VS1000E does not support daisy chaining.

The light source of this luminaire is not replaceable; when the light source reaches its end of life the whole luminaire shall be replaced. (3,3,21 - BS EN IEC 60598-1:2021+A11:2022)

WARRANTY INFORMATION

VIVOSUN provides a 5-year warranty against defects on all VS LED Lights purchased directly from us or through our authorized dealers. This policy serves as our commitment to promptly address any manufacturing defects or premature breakage that may occur during normal use of our products.

Our warranty covers the replacement or refund of purchases that exhibit material defects within five years of the original purchase date. In such events, customers may contact us to initiate the claim process. We will need proof of purchase to verify coverage eligibility.

This policy does not extend to products that have been misused, abused, or purposefully damaged. It also does not cover normal wear and tear or cosmetic defects such as minor scratches.

Customers can rest assured knowing that our products undergo rigorous quality testing procedures. This 5-year warranty reflects our confidence in the durability of our products under normal use.

If any product defects are found, customers are encouraged to contact us immediately. Your satisfaction is our priority, and we are committed to resolving any issues in a professional and timely manner.

WARNING

- This appliance can be used by children aged 8 years and above, as well as by individuals with reduced physical, sensory, or mental capabilities, or those lacking experience and knowledge, provided they have been supervised or instructed on the safe use of the appliance and understand the associated hazards.
- Children should not play with the appliance.
- User maintenance should not be carried out by children without supervision.
- Keep the appliance and its cord out of reach of children under 8 years old.
- If the supply cord is damaged, it must be replaced by the manufacturer, its service agent, or similarly qualified persons to avoid a hazard.
- Never touch the plug or outlet if your hands are wet.
- Use only the cable provided with the device.
- Acceptable operating temperatures range from -20°C to 40°C (-4°F to 104°F).
- Don't place the device in the microwave.
- Avoid looking directly at the lights when they are turned on.
- Do not insert objects into the fan blades.
- Don't insert fingers or objects into the gaps between the light boards.
- Avoid touching the LED diodes when adjusting the light board.
- Don't use water or any detergent to clean the product.



DO NOT dispose of this product with your regular trash. Electrical appliances contain hazardous materials that can harm the environment if not disposed of properly.

Please contact your local government for information on nearby drop-off centers or recycling programs that accept electronic waste.

AVERTISSEMENT

- L'appareil peut être utilisé par des enfants de 8 ans et plus, ainsi que par des personnes ayant des capacités physiques, sensorielles ou mentales réduites, ou un manque d'expérience et de connaissances, à condition qu'elles soient sous surveillance ou qu'elles aient reçu des instructions concernant l'utilisation sécurisée de l'appareil et qu'elles comprennent les dangers associés.
- Les enfants ne doivent pas jouer avec l'appareil.
- La maintenance de l'appareil ne doit pas être effectuée par des enfants non surveillés.
- Gardez l'appareil et son cordon hors de portée des enfants de moins de 8 ans.
- Si le cordon d'alimentation est endommagé, il doit être remplacé par le fabricant, son agent de service ou une personne qualifiée similaire afin d'éviter tout danger.
- Ne touchez jamais la prise ou la prise de courant si vos mains sont mouillées.
- Utilisez uniquement le câble fourni avec l'appareil.
- Les températures de fonctionnement acceptables vont de -20°C à 40°C (-4°F à 104°F).
- Ne placez pas l'appareil dans le micro-ondes.
- Ne regardez pas directement les lumières lorsqu'elles sont allumées.
- Ne mettez pas d'objets dans les pales du ventilateur.
- Ne mettez pas vos doigts ou des objets dans les interstices entre les panneaux lumineux.
- Ne touchez pas les diodes LED lorsque vous réglez le panneau lumineux.
- N'utilisez pas d'eau ou de détergent pour nettoyer le produit.



NE JETEZ PAS ce produit avec vos ordures ménagères régulières. Les appareils électriques contiennent des matériaux dangereux qui peuvent nuire à l'environnement s'ils ne sont pas éliminés correctement. Veuillez contacter autorité locale pour obtenir des informations sur les centres de dépôt ou les programmes de recyclage à proximité qui acceptent les déchets électroniques.

WARNUNG

- Das Gerät kann von Kindern ab 8 Jahren sowie von Personen mit eingeschränkten physischen, sensorischen oder geistigen Fähigkeiten oder mangelnder Erfahrung und Wissen verwendet werden, sofern sie unter Aufsicht stehen oder Anweisungen zum sicheren Gebrauch des Geräts erhalten haben und die damit verbundenen Gefahren verstehen.
- Kinder dürfen nicht mit dem Gerät spielen.
- Wartungsarbeiten am Gerät dürfen nicht von Kindern ohne Aufsicht durchgeführt werden.
- Halten Sie das Gerät und sein Kabel außerhalb der Reichweite von Kindern unter 8 Jahren.
- Wenn das Netzkabel beschädigt ist, muss es vom Hersteller, seinem Kundendienst oder einer ähnlich qualifizierten Person ersetzt werden, um Gefahren zu vermeiden.
- Berühren Sie niemals den Stecker oder die Steckdose, wenn Ihre Hände nass sind.
- Verwenden Sie nur das mit dem Gerät gelieferte Kabel.
- Die zulässigen Betriebstemperaturen liegen zwischen -20°C und 40°C (-4°F bis 104°F).
- Stellen Sie das Gerät nicht in die Mikrowelle.
- Schauen Sie nicht direkt in die Lichter, wenn sie eingeschaltet sind.
- Stecken Sie keine Gegenstände in die Lüfterblätter.
- Stecken Sie keine Finger oder Gegenstände in die Zwischenräume der Lichtplatten.
- Berühren Sie die LED-Dioden nicht, wenn Sie die Lichtplatte einstellen.
- Verwenden Sie kein Wasser oder Reinigungsmittel zur Reinigung des Produkts.



Entsorgen Sie dieses Produkt nicht mit Ihrem regulären Müll. Elektrogeräte enthalten gefährliche Stoffe, die der Umwelt schädigen können, wenn sie nicht ordnungsgemäß entsorgt werden.

Bitte wenden Sie sich an Ihre örtlichen Behörden, um Informationen über Sammelstellen oder Recyclingprogramme zu erhalten, die Elektroschrott annehmen.

AVVERTENZA

- L'apparecchio può essere utilizzato da bambini di 8 anni e più, nonché da persone con capacità fisiche, sensoriali o mentali ridotte o mancanza di esperienza e conoscenza, se sono sotto supervisione o hanno ricevuto istruzioni sull'uso sicuro dell'apparecchio e comprendono i pericoli associati.
- I bambini non devono giocare con l'apparecchio.
- La manutenzione dell'utente non deve essere effettuata da bambini senza supervisione.
- Tenere l'apparecchio e il suo cavo fuori dalla portata dei bambini di età inferiore agli 8 anni.
- Se il cavo di alimentazione è danneggiato, deve essere sostituito dal produttore, dal suo agente di servizio o da persone con qualifiche simili per evitare pericoli.
- Non toccare mai la spina o la presa se le mani sono bagnate.
- Utilizzare solo il cavo fornito con l'apparecchio.
- Le temperature di funzionamento accettabili vanno da -20°C a 40°C (-4°F a 104°F).
- Non mettere l'apparecchio nel microonde.
- Non guardare direttamente le luci quando sono accese.
- Non inserire oggetti nelle pale del ventilatore.
- Non mettere le dita o oggetti negli spazi tra i pannelli luminosi.
- Non toccare i diodi LED quando si regola il pannello luminoso.
- Non usare acqua o detersivi per pulire il prodotto.



NON GETTARE questo prodotto con i rifiuti domestici normali. Gli apparecchi elettrici contengono materiali pericolosi che possono danneggiare l'ambiente se non vengono smaltiti correttamente.

Contattare il governo locale per informazioni sui centri di raccolta o i programmi di riciclaggio nelle vicinanze che accettano rifiuti elettronici.

ADVERTENCIA

- El aparato puede ser utilizado por niños de 8 años en adelante, así como por personas con capacidades físicas, sensoriales o mentales reducidas, o con falta de experiencia y conocimientos, siempre que estén bajo supervisión o hayan recibido instrucciones sobre el uso seguro del aparato y comprendan los riesgos involucrados.
- Los niños no deben jugar con el aparato.
- El mantenimiento por parte del usuario no debe ser realizado por niños sin supervisión.
- Mantenga el aparato y su cable fuera del alcance de los niños menores de 8 años.
- Si el cable de suministro está dañado, debe ser reemplazado por el fabricante, su agente de servicio o personas con cualificaciones similares para evitar riesgos.
- Nunca toque el enchufe o la toma de corriente si sus manos están húmedas.
- Use únicamente el cable proporcionado con el dispositivo.
- Las temperaturas de funcionamiento aceptables oscilan entre -20°C y 40°C (-4°F a 104°F).
- No coloque el dispositivo en el microondas.
- No mire directamente las luces cuando estén encendidas.
- No ponga objetos en las aspas del ventilador.
- No introduzca dedos ni objetos en las ranuras entre las placas de luz.
- No toque los diodos LED al ajustar la placa de luz.
- No use agua ni detergente para limpiar el producto.



NO DESEE este producto con la basura normal. Los aparatos eléctricos contienen materiales peligrosos que pueden dañar el medio ambiente si no se eliminan correctamente.

Por favor, contacte con su gobierno local para obtener información sobre los centros de reciclaje o programas de reciclaje cercanos que acepten desechos electrónicos.

WAARSCHUWING

- Het apparaat kan worden gebruikt door kinderen van 8 jaar en ouder en door personen met verminderde fysieke, zintuiglijke of mentale capaciteiten, of gebrek aan ervaring en kennis, mits zij toezicht of instructies hebben ontvangen over het veilige gebruik van het apparaat en de bijbehorende risico's begrijpen.
- Kinderen mogen niet met het apparaat spelen.
- Onderhoud door de gebruiker mag niet door kinderen zonder toezicht worden uitgevoerd.
- Houd het apparaat en de kabel buiten het bereik van kinderen jonger dan 8 jaar.
- Als de voedingskabel beschadigd is, moet deze worden vervangen door de fabrikant, de servicemanager of gelijkwaardige personen om gevaar te voorkomen.
- Raak de stekker of het stopcontact nooit aan als je handen nat zijn.
- Gebruik **alleen** de kabel die bij het apparaat is geleverd.
- De aanvaardbare bedrijfstemperaturen variëren van -20°C tot 40°C (-4°F tot 104°F).
- Plaats het apparaat niet in de magnetron.
- Kijk niet direct naar de lichten als ze aan zijn.
- Stop geen voorwerpen in de ventilatorbladen.
- Stop geen vingers of voorwerpen in de openingen tussen de lichtpanelen.
- Raak de LED-dioden niet aan bij het aanpassen van het lichtpaneel.
- Gebruik geen water of schoonmaakmiddelen om het product schoon te maken.



GOOI DIT PRODUCT NIET MET UW REGULIERE AFVAL WEG. Elektrische apparaten bevatten gevaarlijke materialen die het milieu kunnen schaden als ze niet op de juiste manier worden weggegooid.

Neem contact op met uw lokale overheid voor informatie over nabijgelegen inleverpunten of recyclingprogramma's die elektronisch afval accepteren.

Designed by **VIVOSUN** in California.
Made in China