

VIVOSUN



430W LED
USER MANUAL

Love
what
you
grow™





Welcome to **VIVOSUN**

Thank you for choosing VIVOSUN. We are committed to product quality and friendly customer service. If you have any questions or suggestions, please don't hesitate to contact us.

SPECIFICATIONS

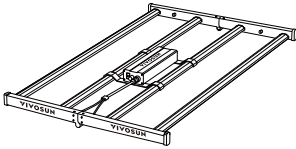
Input Voltage	100-277V	Fixture Dimensions	41.3"x27.6"x2.2"
Frequency	50/60Hz	Weight	16.1 lbs
Input Power	430W		

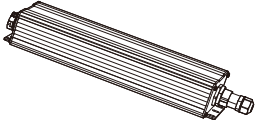
PRODUCT CONTENTS

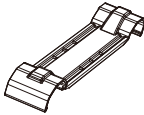
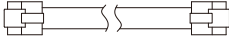
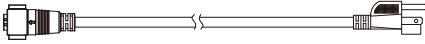
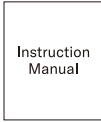
		
A LED Light (1 pc)	B Lance Hangers (2 pcs)	C LED Driver (1 pc)
		
D Screw (5 pcs)	E Driver Mounts (2 pcs)	F RJ11 Cable 10ft (1 pc)
		
G Input Power Cord 10ft (1 pc)	H Instruction Manual	

DIMENSIONS

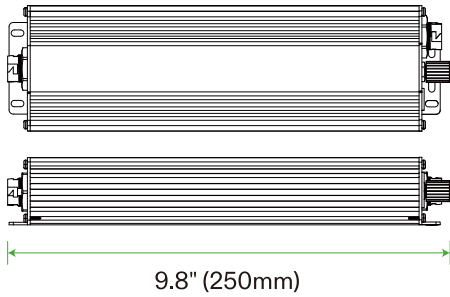
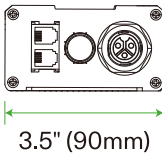
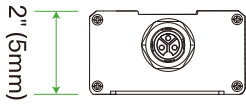
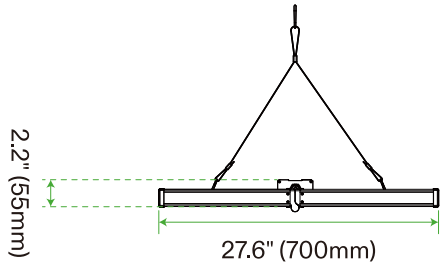
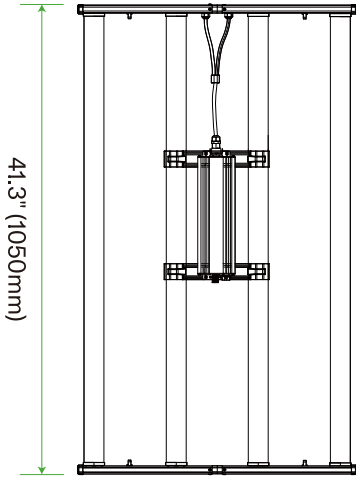

INSTALLATION

STEP 1

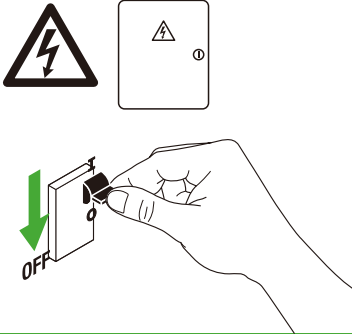

STEP 2.A.1

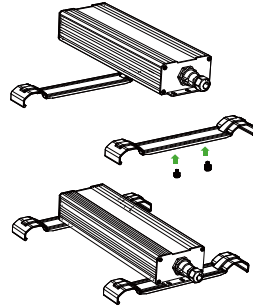

STEP 2.A.2

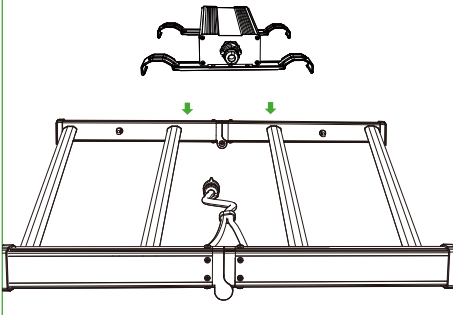

STEP 3

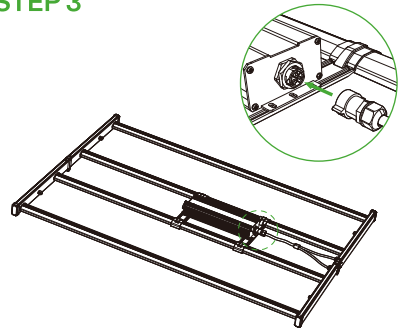

STEP 4.A.1

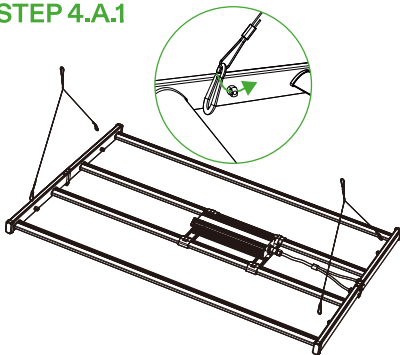

STEP 4.A.2

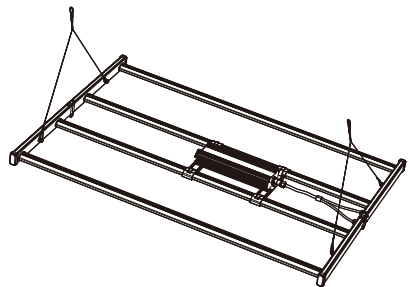

INSTALLATION

STEP 5

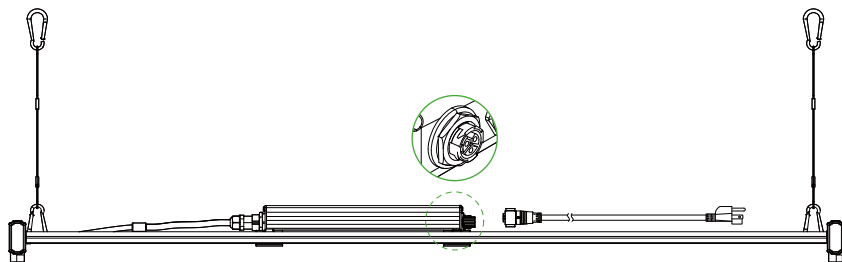

STEP 6

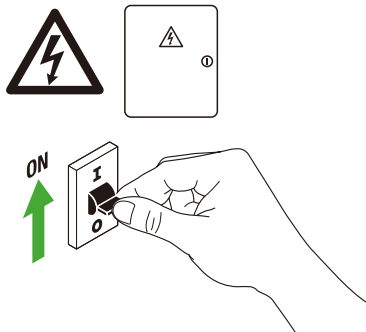

CONNECT UP TO 160 LEDS

Set the knob to EXT

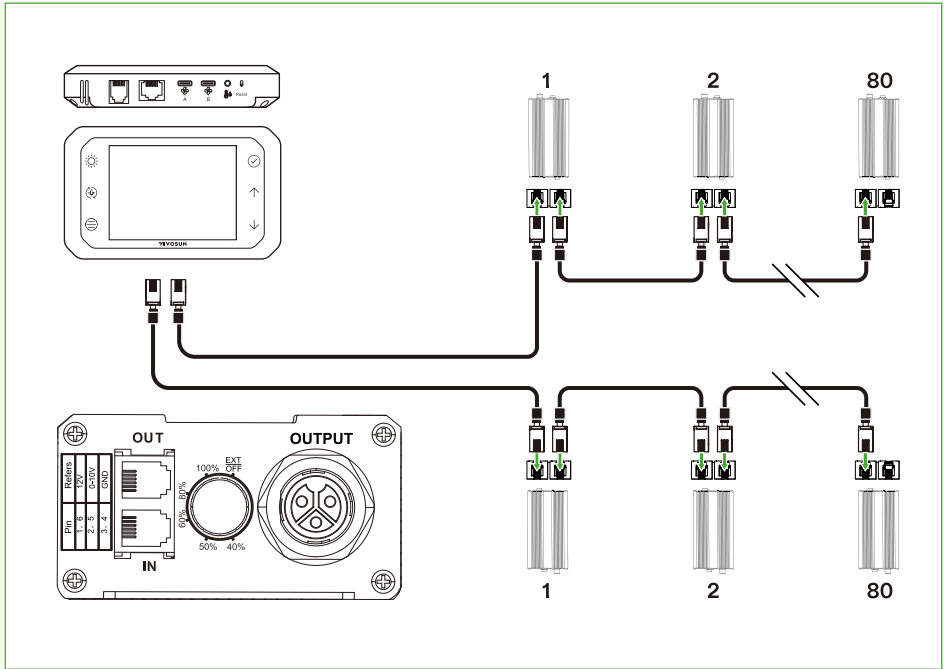

Designed by **YIVOSUN** in California.
Made in China