

VIVOSUN



AeroLight SE

USER MANUAL

Love what you grow™

Welcome to **VIVOSUN**

At Vivosun, quality craftsmanship and innovation are at the core of every product we create. Should you require further support or wish to share any suggestions, please don't hesitate to contact us.

PRODUCTS INCLUDED IN THIS MANUAL:

Product	SKU
AeroLight A100 SE	VSA100SE
AeroLight A150 SE	VSA150SE
AeroLight AW200 SE	VSA200SE
AeroLight AW400 SE	VSAW400SE

CONTENTS

Key Features	1
Product Contents	3
Smart Grow System	5
Spectrum.....	6
Dimensions.....	7
Specifications.....	11
Installation	12
Application.....	16
Warranty Information.....	17
FCC ID Statement	18
Warning	19

KEY FEATURES

VSA100SE/VSA150SE

2-IN-1 GROW LIGHT

Patented grow light design with integrated highly efficient circulation fan.

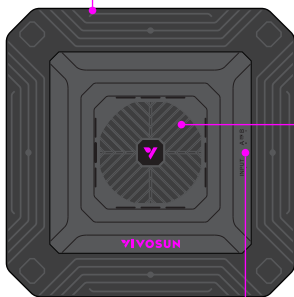

SMART CONTROL

Smart settings for LEDs and fan such as sunrise/sunset and natural wind mode via the GrowHub Controller.

BETTER CIRCULATION

Strategically placed central fan promotes exceptional air circulation, ensuring optimal CO₂ levels and proper humidity control for your plants.

UNIFORM LIGHT & AIR

Innovative hollow light design and integrated wind guide ensure uniform light penetration and air circulation across your entire plant canopy.

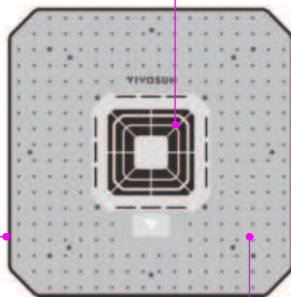

FULL SPECTRUM

Full-spectrum sunlike lighting with far-red lighting; offers greater spectral range and energy conversion for your plants with maximum PAR output at various distances.

FR-ENHANCED

High-efficiency white LEDs combined with precise 660nm deep red and 730nm far red LEDs to optimize plant growth.

KEY FEATURES

VSA200SE/VSAW400SE

2-IN-1 GROW LIGHT

Patented grow light design with integrated highly reliable circulation fan.

BETTER CIRCULATION

With the central placement of the fan you have better air, CO₂ circulation, and humidity.

UNIFORM LIGHT & AIR

Creative light design and wind guide provide uniform light and wind on plants' canopy.

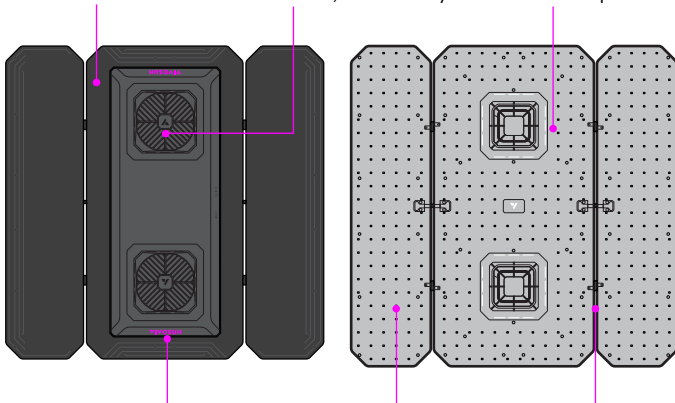

SMART CONTROL

Smart settings for LEDs and fan like sunrise/sunset and natural wind via the GrowHub Controller.

FULL SPECTRUM

Full-spectrum unlike lighting with far-red lighting; offers greater spectral range and energy conversion for your plants with maximum PAR output at various distances.

FOLDABLE

Foldable design with 2 angle-adjustable wings provides various, flexible light coverage.

PRODUCT CONTENTS

VSA100SE/VSA150SE

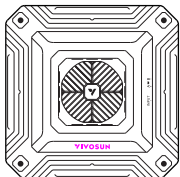

LED Light
x 1pc



Power Cord
x 1pc

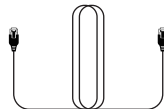

RJ45 Network Cable
x 1pc

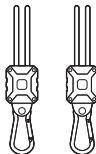

Rope Hanger
x 2pcs

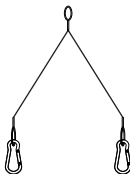

Wire Ropes
x 2pcs

PRODUCT CONTENTS

VSA200SE/VSAW400SE

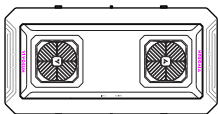

LED Light
x 1pc



Power Cord
x 1pc

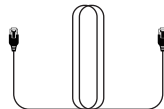

RJ45 Network Cable
x 1pc

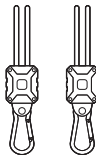

Rope Hanger
x 2pcs

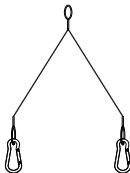

Wire Ropes
x 2pcs

Control devices via Wi-Fi or Bluetooth



GrowHub easily monitors and controls from a single screen

Power devices remotely via GrowHub's smart plugs

Thermostat A/C Heater Dehumidifier

Products Coming Soon

VIVOSUN



Smart Grow System™

Connect Devices via GrowHub & Mobile App

SPECTRUM

The AeroLight SE is a full-spectrum device, covering all stages of plant growth.

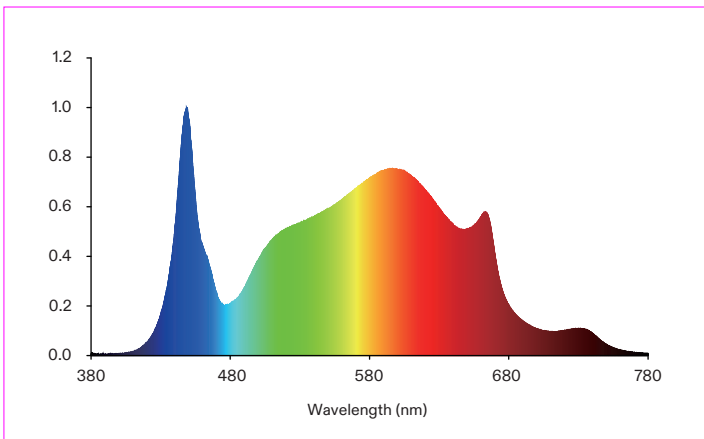

DIMENSIONS

VSA100SE

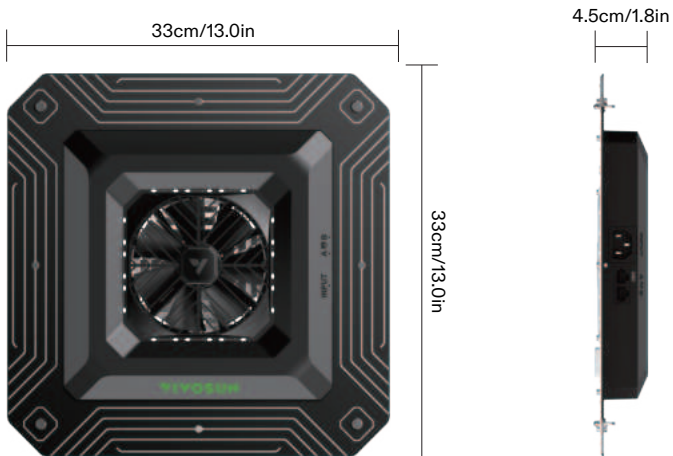

Top View

Side View

DIMENSIONS

VSA150SE

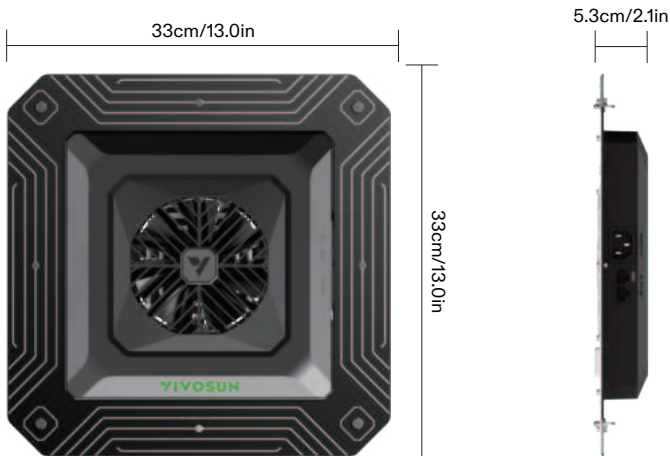

Top View

Side View

DIMENSIONS

VSA200SE

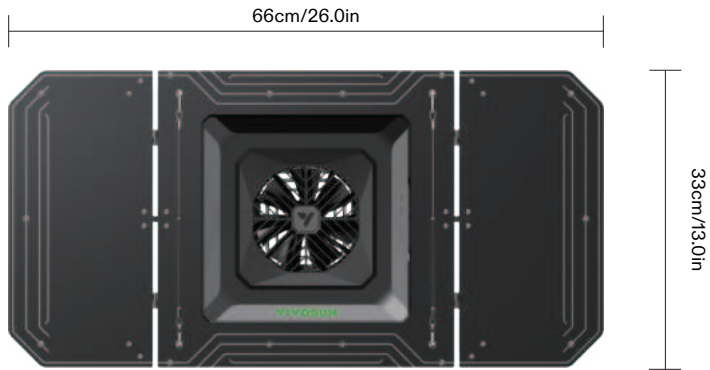

Top View



Side View

DIMENSIONS

VSAW400SE



Top View

Side View

SPECIFICATIONS

	VSA100SE	VSA150SE	VSA200SE	VSAW400SE
Dimensions	13"L x 13"W x 1.8"H 33cm x 33cm x 4.5cm	13"L x 13"W x 2.1"H 33cm x 33cm x 5.3cm	26"L x 13"W x 2.3"H 66cm x 33cm x 5.8cm	26"L x 26.4"W x 2.2"H 66cm x 67cm x 5.6cm
Weight	5.1 lb./2.32 kg	5.7 lb./2.58 kg	6.9 lb./3.11 kg	12.5lb./5.69kg
Input Voltage	120-240Vac/50-60Hz			
Power Factor	>0.9			
Input Power	100W	150W	200W	400W
Light	LED Source	White with 660nm Deep Red & 730nm Far Red		
	Spectrum	Full spectrum; 380nm-780nm, rich 660nm		
	Light Distribution	120°	Adjustable	
	Dimming	20%-100%/OFF (via GrowHub and VIVOSUN app)		
Fan	Bearing	Dual Ball Bearing		
	Speed	2200 RPM.		
	Airflow	84 CFM	168 CFM	
	Noise Level	33 db(A)	66 db(A)	
Daisy Chaining	up to 12 Lights (via GrowHub)			
Lifespan	>50,000 hours			
Certifications	ETL,CE,FCC and IP65			

INSTALLATION

STEP 1

Attach the wire ropes to the frame of the AeroLight SE. Next, clip the carabiners of the rope hangers to the wire ropes.

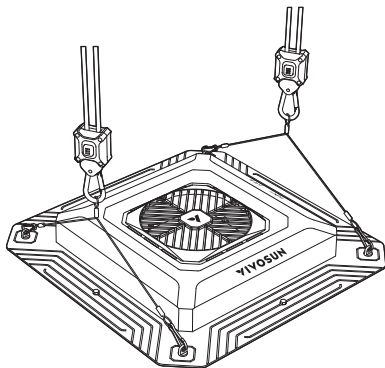

INSTALLATION

STEP 2

Loop the other end of the rope hangers around the crossbeam as shown in the diagram. Lock the carabiners to the rope to secure the grow light to the pole.

STEP 3

Adjust the height of your grow light by pressing the buttons on the rope hangers and lifting until you find the correct height for your grown light .

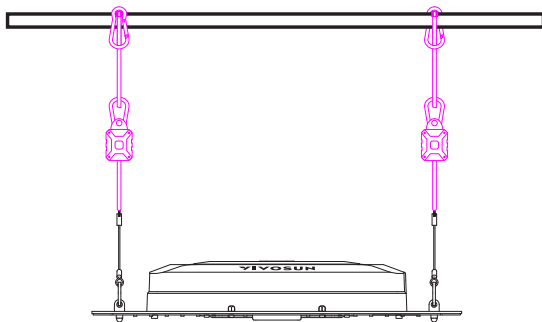

INSTALLATION

STEP 4

For VSA200SE & VSAW400SE, please unfold the light board and adjust to an appropriate angle.

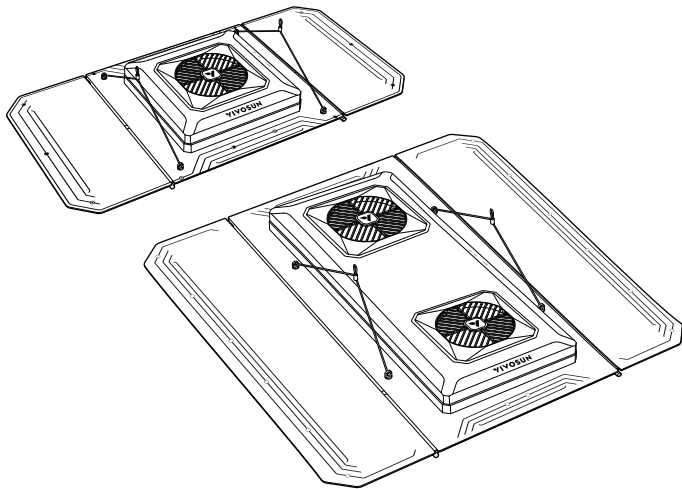

INSTALLATION

VSA200SE/VSAW400SE

ADJUSTING THE LIGHT DISTRIBUTION

Adjust the angle of the light board on the side to change the light distribution for larger coverage or higher light intensity for different grow stages.



STANDARD

Standard light coverage and uniformity.

WIDTH

Larger light coverage with more light for plants on the sides of your lights through improved coverage area. Better for seedling and vegetative stages of growth.

NARROW

Higher light intensity with smaller light coverage. Better for the flowering stage of growth.

APPLICATION

SUGGESTED HANGING DISTANCE & LIGHTING TIME

Product		Seedling	Veg	Early Flower	Late Flower	Tent Size
PPFD Target		150-250	300-500	500-700	700-1000	
Time		18h	18h	12h	12h	
VSA100SE	Distance	24"	18"	12"	12"	2'x2'
	Dimming Level	50%	75%	75%	100%	
VSA150SE	Distance	24"	18"	14"	14"	2'x2'
	Dimming Level	25%	50%	75%	100%	
VSA200SE	Distance	24"	18"	12"	12"	2'x4'
	Dimming Level	50%	75%	75%	100%	
VSAW400SE	Distance	24"	20"	14"	14"	4'x4'
	Dimming Level	50%	75%	75%	100%	

Distance: Light to canopy distance.

Set the LED power on high and place the light further away from your plants to cover a wider area, or set the LED at a lower power and place the light closer to your plants for less coverage but higher energy efficiency.

WARRANTY INFORMATION

VIVOSUN provides a 3-year warranty against defects on all AeroLight SE products purchased directly from us or through our authorized dealers. This policy serves as our commitment to promptly address any manufacturing defects or premature breakage that may occur during normal use of our products.

Our warranty covers the replacement or refund of purchases that exhibit material defects within three years of the original purchase date. In such events, customers may contact us to initiate the claim process. We will need proof of purchase to verify coverage eligibility. This policy does not extend to products that have been misused, abused, or purposefully damaged. It also does not cover normal wear and tear or cosmetic defects such as minor scratches.

Customers can rest assured knowing that our products undergo rigorous quality testing procedures. This 3-year warranty reflects our confidence in the durability of our products under normal use.

If any product defects are found, customers are encouraged to contact us immediately. Your satisfaction is our priority, and we are committed to resolving any issues in a professional and timely manner.

FCC ID STATEMENT

The GrowHub E25 controller complies with part 15 of the FCC Rules. Operation is subject to the following two conditions:

(1) This device may not cause harmful interference, and (2) this device must accept any interference received, including interference that may cause undesired operation.

NOTE: This equipment has been tested and found to comply with the limits for a Class B digital device, pursuant to part 15 of the FCC Rules. These limits are designed to provide reasonable protection against harmful interference in a residential installation. This equipment generates, uses and can radiate radio frequency energy and, if not installed and used in accordance with the instructions, may cause harmful interference to radio communications. However, there is no guarantee that interference will not occur in a particular installation. If this equipment does cause harmful interference to radio or television reception, which can be determined by turning the equipment off and on, the user is encouraged to try to correct the interference by one or more of the following measures:

- Reorient or relocate the receiving antenna.
- Increase the distance between the equipment and receiver.
- Connect the equipment into an outlet on a circuit different from that to which the receiver is connected.
- Consult the dealer or an experienced radio/TV technician for help.

Warning: Changes or modifications not expressly approved by the party responsible for compliance could void the user's authority to operate the equipment.

WARNING

- This appliance can be used by children aged 8 years and above, as well as by individuals with reduced physical, sensory, or mental capabilities, or those lacking experience and knowledge, provided they have been supervised or instructed on the safe use of the appliance and understand the associated hazards.
- Children should not play with the appliance.
- User maintenance should not be carried out by children without supervision.
- Keep the appliance and its cord out of reach of children under 8 years old.
- If the supply cord is damaged, it must be replaced by the manufacturer, its service agent, or similarly qualified persons to avoid a hazard.
- Never touch the plug or outlet if your hands are wet.
- Use only the cable provided with the device.
- Acceptable operating temperatures range from -20°C to 40°C (-4°F to 104°F).
- Don't place the device in the microwave.
- Avoid looking directly at the lights when they are turned on.
- Do not insert objects into the fan blades.
- Don't cover the fan or spray anything on it.
- Don't insert fingers or objects into the gaps between the light boards.
- Avoid touching the LED diodes when adjusting the light board.
- Don't adjust the angle of the light board beyond the specified limits (Aerolight Wing).
- Don't use water or any detergent to clean the product.



DO NOT dispose of this product with your regular trash. Electrical appliances contain hazardous materials that can harm the environment if not disposed of properly.

Please contact your local government for information on nearby drop-off centers or recycling programs that accept electronic waste.

AVERTISSEMENT

- L'appareil peut être utilisé par des enfants de 8 ans et plus, ainsi que par des personnes ayant des capacités physiques, sensorielles ou mentales réduites, ou un manque d'expérience et de connaissances, à condition qu'elles soient sous surveillance ou qu'elles aient reçu des instructions concernant l'utilisation sécurisée de l'appareil et qu'elles comprennent les dangers associés.
- Les enfants ne doivent pas jouer avec l'appareil.
- La maintenance de l'appareil ne doit pas être effectuée par des enfants non surveillés.
- Gardez l'appareil et son cordon hors de portée des enfants de moins de 8 ans.
- Si le cordon d'alimentation est endommagé, il doit être remplacé par le fabricant, son agent de service ou une personne qualifiée similaire afin d'éviter tout danger.
- Ne touchez jamais la prise ou la prise de courant si vos mains sont mouillées.
- Utilisez uniquement le câble fourni avec l'appareil.
- Les températures de fonctionnement acceptables vont de -20°C à 40°C (-4°F à 104°F).
- Ne placez pas l'appareil dans le micro-ondes.
- Ne regardez pas directement les lumières lorsqu'elles sont allumées.
- Ne mettez pas d'objets dans les pales du ventilateur.
- Ne couvrez pas le ventilateur et ne vaporisez rien dessus.
- Ne mettez pas vos doigts ou des objets dans les interstices entre les panneaux lumineux.
- Ne touchez pas les diodes LED lorsque vous réglez le panneau lumineux.
- Ne réglez pas l'angle du panneau lumineux au-delà des limites spécifiées (Aerolight Wing).
- N'utilisez pas d'eau ou de détergent pour nettoyer le produit.



NE JETEZ PAS ce produit avec vos ordures ménagères régulières. Les appareils électriques contiennent des matériaux dangereux qui peuvent nuire à l'environnement s'ils ne sont pas éliminés correctement.

Veillez contacter autorité locale pour obtenir des informations sur les centres de dépôt ou les programmes de recyclage à proximité qui acceptent les déchets électroniques.

WARNUNG

- Das Gerät kann von Kindern ab 8 Jahren sowie von Personen mit eingeschränkten physischen, sensorischen oder geistigen Fähigkeiten oder mangelnder Erfahrung und Wissen verwendet werden, sofern sie unter Aufsicht stehen oder Anweisungen zum sicheren Gebrauch des Geräts erhalten haben und die damit verbundenen Gefahren verstehen.
- Kinder dürfen nicht mit dem Gerät spielen.
- Wartungsarbeiten am Gerät dürfen nicht von Kindern ohne Aufsicht durchgeführt werden.
- Halten Sie das Gerät und sein Kabel außerhalb der Reichweite von Kindern unter 8 Jahren.
- Wenn das Netzkabel beschädigt ist, muss es vom Hersteller, seinem Kundendienst oder einer ähnlich qualifizierten Person ersetzt werden, um Gefahren zu vermeiden.
- Berühren Sie niemals den Stecker oder die Steckdose, wenn Ihre Hände nass sind.
- Verwenden Sie nur das mit dem Gerät gelieferte Kabel.
- Die zulässigen Betriebstemperaturen liegen zwischen -20°C und 40°C (-4°F bis 104°F).
- Stellen Sie das Gerät nicht in die Mikrowelle.
- Schauen Sie nicht direkt in die Lichter, wenn sie eingeschaltet sind.
- Stecken Sie keine Gegenstände in die Lüfterblätter.
- Bedecken Sie den Lüfter nicht und sprühen Sie nichts darauf.
- Stecken Sie keine Finger oder Gegenstände in die Zwischenräume der Lichtplatten.
- Berühren Sie die LED-Dioden nicht, wenn Sie die Lichtplatte einstellen.
- Verstellen Sie den Winkel der Lichtplatte nicht über die vorgegebenen Grenzen hinaus (Aerolight Wing).
- Verwenden Sie kein Wasser oder Reinigungsmittel zur Reinigung des Produkts.



Entsorgen Sie dieses Produkt nicht mit Ihrem regulären Müll. Elektrogeräte enthalten gefährliche Stoffe, die der Umwelt schädigen können, wenn sie nicht ordnungsgemäß entsorgt werden.

Bitte wenden Sie sich an Ihre örtlichen Behörden, um Informationen über Sammelstellen oder Recyclingprogramme zu erhalten, die Elektroschrott annehmen.

AVVERTENZA

- L'apparecchio può essere utilizzato da bambini di 8 anni e più, nonché da persone con capacità fisiche, sensoriali o mentali ridotte o mancanza di esperienza e conoscenza, se sono sotto supervisione o hanno ricevuto istruzioni sull'uso sicuro dell'apparecchio e comprendono i pericoli associati.
- I bambini non devono giocare con l'apparecchio.
- La manutenzione dell'utente non deve essere effettuata da bambini senza supervisione.
- Tenere l'apparecchio e il suo cavo fuori dalla portata dei bambini di età inferiore agli 8 anni.
- Se il cavo di alimentazione è danneggiato, deve essere sostituito dal produttore, dal suo agente di servizio o da persone con qualifiche simili per evitare pericoli.
- Non toccare mai la spina o la presa se le mani sono bagnate.
- Utilizzare solo il cavo fornito con l'apparecchio.
- Le temperature di funzionamento accettabili vanno da -20°C a 40°C (-4°F a 104°F).
- Non mettere l'apparecchio nel microonde.
- Non guardare direttamente le luci quando sono accese.
- Non inserire oggetti nelle pale del ventilatore.
- Non coprire il ventilatore e non spruzzare nulla su di esso.
- Non mettere le dita o oggetti negli spazi tra i pannelli luminosi.
- Non toccare i diodi LED quando si regola il pannello luminoso.
- Non regolare l'angolo del pannello luminoso oltre i limiti specificati (Aerolight wing).
- Non usare acqua o detersivi per pulire il prodotto.



NON GETTARE questo prodotto con i rifiuti domestici normali. Gli apparecchi elettrici contengono materiali pericolosi che possono danneggiare l'ambiente se non vengono smaltiti correttamente.

Contattare il governo locale per informazioni sui centri di raccolta o i programmi di riciclaggio nelle vicinanze che accettano rifiuti elettronici.

ADVERTENCIA

- El aparato puede ser utilizado por niños de 8 años en adelante, así como por personas con capacidades físicas, sensoriales o mentales reducidas, o con falta de experiencia y conocimientos, siempre que estén bajo supervisión o hayan recibido instrucciones sobre el uso seguro del aparato y comprendan los riesgos involucrados.
- Los niños no deben jugar con el aparato.
- El mantenimiento por parte del usuario no debe ser realizado por niños sin supervisión.
- Mantenga el aparato y su cable fuera del alcance de los niños menores de 8 años.
- Si el cable de suministro está dañado, debe ser reemplazado por el fabricante, su agente de servicio o personas con cualificaciones similares para evitar riesgos.
- Nunca toque el enchufe o la toma de corriente si sus manos están húmedas.
- Use únicamente el cable proporcionado con el dispositivo.
- Las temperaturas de funcionamiento aceptables oscilan entre -20°C y 40°C (-4°F a 104°F).
- No coloque el dispositivo en el microondas.
- No mire directamente las luces cuando estén encendidas.
- No ponga objetos en las aspas del ventilador.
- No cubra el ventilador ni le aplique ningún tipo de spray.
- No introduzca dedos ni objetos en las ranuras entre las placas de luz.
- No toque los diodos LED al ajustar la placa de luz.
- No ajuste el ángulo de la placa de luz más allá de los límites especificados (Aerolight wing).
- No use agua ni detergente para limpiar el producto.



NO DESEE este producto con la basura normal. Los aparatos eléctricos contienen materiales peligrosos que pueden dañar el medio ambiente si no se eliminan correctamente.

Por favor, contacte con su gobierno local para obtener información sobre los centros de reciclaje o programas de reciclaje cercanos que acepten desechos electrónicos.

WAARSCHUWING

- Het apparaat kan worden gebruikt door kinderen van 8 jaar en ouder en door personen met verminderde fysieke, zintuiglijke of mentale capaciteiten, of gebrek aan ervaring en kennis, mits zij toezicht of instructies hebben ontvangen over het veilige gebruik van het apparaat en de bijbehorende risico's begrijpen.
- Kinderen mogen niet met het apparaat spelen.
- Onderhoud door de gebruiker mag niet door kinderen zonder toezicht worden uitgevoerd.
- Houd het apparaat en de kabel buiten het bereik van kinderen jonger dan 8 jaar.
- Als de voedingskabel beschadigd is, moet deze worden vervangen door de fabrikant, de servicemanager of gelijkwaardige personen om gevaar te voorkomen.
- Raak de stekker of het stopcontact nooit aan als je handen nat zijn.
- Gebruik alleen de kabel die bij het apparaat is geleverd.
- De aanvaardbare bedrijfstemperaturen variëren van -20°C tot 40°C (-4°F tot 104°F).
- Plaats het apparaat niet in de magnetron.
- Kijk niet direct naar de lichten als ze aan zijn.
- Stop geen voorwerpen in de ventilatorbladen.
- Dek de ventilator niet af en spray niets op de ventilator.
- Stop geen vingers of voorwerpen in de openingen tussen de lichtpanelen.
- Raak de LED-dioden niet aan bij het aanpassen van het lichtpaneel.
- Pas de hoek van het lichtpaneel niet aan buiten de gespecificeerde limieten (Aerolight-vleugel).
- Gebruik geen water of schoonmaakmiddelen om het product schoon te maken.



GOOI DIT PRODUCT NIET MET UW REGULIERE AFVAL WEG. Elektrische apparaten bevatten gevaarlijke materialen die het milieu kunnen schaden als ze niet op de juiste manier worden weggegooid.

Neem contact op met uw lokale overheid voor informatie over nabijgelegen inleverpunten of recyclingprogramma's die elektronisch afval accepteren.

VAROVÁNÍ

- Toto zařízení mohou používat děti starší 8 let a osoby se sníženými fyzickými, smyslovými nebo duševními schopnostmi nebo osoby bez zkušeností a znalostí, pokud byly pod dohledem nebo byly poučeny o bezpečném používání zařízení a rozumí souvisejícím rizikům.
- Děti by si neměly hrát s přístrojem.
- Údržbu uživatelem by neměly provádět děti bez dozoru.
- Uchovávejte přístroj a jeho kabel mimo dosah dětí mladších 8 let.
- Pokud je napájecí kabel poškozen, musí být vyměněn výrobcem, jeho servisním zástupcem nebo podobně kvalifikovanými osobami, aby se předešlo nebezpečí.
- Nikdy se nedotýkejte zástrčky nebo zásuvky, pokud máte mokré ruce.
- Používejte pouze kabel dodávaný s přístrojem.
- Přípustné provozní teploty se pohybují od -20°C do 40°C (-4°F do 104°F).
- Nepokládejte zařízení do mikrovlnné trouby.
- Vyhněte se přímému pohledu na světla, když jsou zapnutá.
- Nevkládejte předměty do lopatek ventilátoru.
- Nepokryvejte ventilátor ani na něj nestříkejte žádná látky.
- Nevkládejte prsty nebo předměty do mezer mezi světelnými deskami.
- Při úpravě světelné desky se nedotýkejte LED diod.
- Neupravujte úhel světelné desky nad stanovené limity (Aerolight Wing).
- Nepoužívejte vodu ani žádné čisticí prostředky k čištění produktu.



NEVYHAZUJTE tento produkt s běžným odpadem. Elektrická zařízení obsahují nebezpečné materiály, které mohou poškodit životní prostředí, pokud nejsou správně zlikvidovány.

Kontaktujte místní úřady pro informace o blízkých sběrných místech nebo recyklačních programech, které přijímají elektronický odpad.

OSTRZEŻENIE

- To urządzenie może być używane przez dzieci w wieku 8 lat i starsze oraz przez osoby z ograniczonymi możliwościami fizycznymi, sensorycznymi lub umysłowymi lub brakującym doświadczeniem i wiedzą, pod warunkiem, że są nadzorowane lub poinstruowane o bezpiecznym użytkowaniu urządzenia i rozumieją związane z nim zagrożenia.
- Dzieci nie powinny bawić się urządzeniem.
- Konserwacja przez użytkownika nie powinna być przeprowadzana przez dzieci bez nadzoru.
- Trzymaj urządzenie i jego kabel z dala od dzieci poniżej 8 roku życia.
- Jeśli kabel zasilający jest uszkodzony, musi zostać wymieniony przez producenta, jego przedstawiciela serwisowego lub osoby o podobnych kwalifikacjach, aby uniknąć zagrożenia.
- Nigdy nie dotykaj wtyczki ani gniazdka, jeśli Twoje ręce są mokre.
- Używaj tylko kabla dostarczonego z urządzeniem.
- Dopuszczalne temperatury pracy wynoszą od -20°C do 40°C (-4°F do 104°F).
- Nie umieszczaj urządzenia w kuchence mikrofalowej.
- Unikaj patrzenia bezpośrednio na światła, gdy są włączone.
- Nie wkładaj przedmiotów do łopatek wentylatora.
- Nie przykrywaj wentylatora ani nie spryskuj go niczym.
- Nie wkładaj palców ani przedmiotów w szczeliny między panelami świetlnymi.
- Unikaj dotykania diod LED podczas regulowania panelu świetlnego.
- Nie reguluj kąta panelu świetlnego poza określone limity (Aerolight Wing).
- Nie używaj wody ani detergentów do czyszczenia produktu.



NIE WYRZUCAJ TEGO PRODUKTU ZWYKŁYMI ŚMIECIAMI. Urządzenia elektryczne zawierają niebezpieczne materiały, które mogą zaszkodzić środowisku, jeśli nie zostaną prawidłowo zutylizowane.

Skontaktuj się z lokalnym rządem, aby uzyskać informacje o pobliskich punktach zbiórki lub programach recyklingu, które akceptują odpady elektroniczne.

VARNING

- Denna apparat kan användas av barn från 8 år och uppåt, samt av personer med nedsatta fysiska, sensoriska eller mentala förmågor, eller de som saknar erfarenhet och kunskap, förutsatt att de har övervakat eller instruerats om hur man använder apparaten på ett säkert sätt och förstår de tillhörande riskerna.
- Barn ska inte leka med apparaten.
- Användarunderhåll ska inte utföras av barn utan övervakning.
- Håll apparaten och dess kabel utom räckhåll för barn under 8 år.
- Om strömkabeln är skadad måste den ersättas av tillverkaren, dess serviceagent eller liknande kvalificerade personer för att undvika en risk.
- Rör aldrig vid kontakten eller uttaget om dina händer är blöta.
- Använd endast den kabel som medföljer enheten.
- Acceptabla drifttemperaturer sträcker sig från -20°C till 40°C (-4°F till 104°F).
- Placera inte enheten i mikrovågsugn.
- Undvik att titta direkt på lamporna när de är påslagna.
- Stoppa inte in föremål i fläktbladen.
- Täck inte fläkten eller spraya något på den.
- Sätt inte fingrar eller föremål i springorna mellan lamporna.
- Undvik att röra LED-dioderna när du justerar ljusplattan.
- Justera inte vinkeln på ljusplattan utöver de angivna gränserna (Aerolight Wing).
- Använd inte vatten eller något rengöringsmedel för att rengöra produkten.



KASTA INTE DENNA PRODUKT MED DIN VANLIGA SOPA. Elektriska apparater innehåller farliga material som kan skada miljön om de inte bortskafts på rätt sätt.

Kontakta din lokala myndighet för information om närliggande avlämningscentraler eller återvinningsprogram som accepterar elektroniskt avfall.

Made in China