

# VIVOSUN



## 300W LED USER MANUAL

Love  
what  
you  
grow™





Welcome to **VIVOSUN**

Thank you for choosing VIVOSUN. We are committed to product quality and friendly customer service. If you have any questions or suggestions, please don't hesitate to contact us.

# SPECIFICATIONS

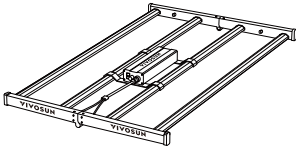
Input Voltage	100-277V	Fixture Dimensions	41.3"x27.6"x2.2"
Frequency	50/60Hz	Weight	16.1 lbs
Input Power	300W		

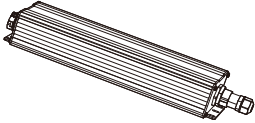
# PRODUCT CONTENTS

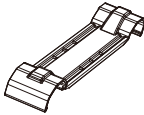
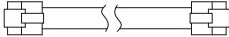
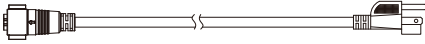
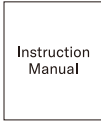
		
<b>A</b> LED Light (1 pc)	<b>B</b> Lance Hangers (2 pcs)	<b>C</b> LED Driver (1 pc)
		
<b>D</b> Screw (5 pcs)	<b>E</b> Driver Mounts (2 pcs)	<b>F</b> RJ11 Cable 10ft (1 pc)
		
<b>G</b> Input Power Cord 10ft (1 pc)	<b>H</b> Instruction Manual	

# DIMENSIONS

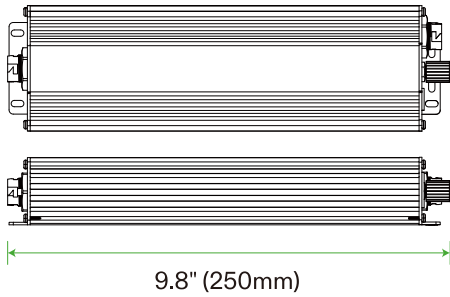
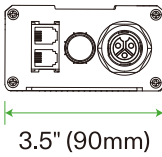
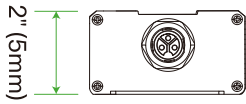
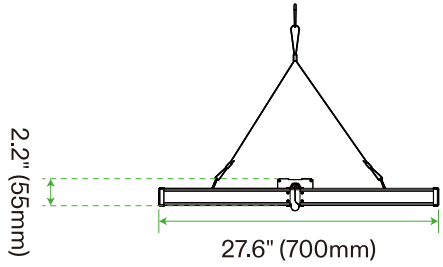
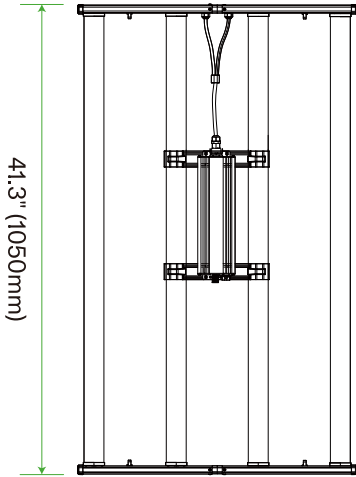

# INSTALLATION

## STEP 1

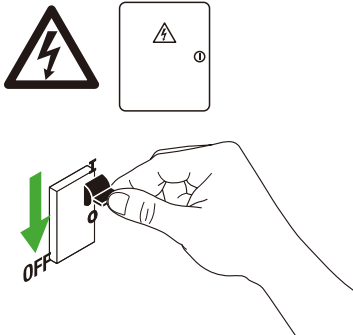

## STEP 2.A.1

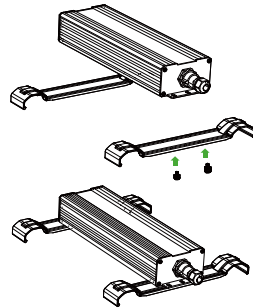

## STEP 2.A.2

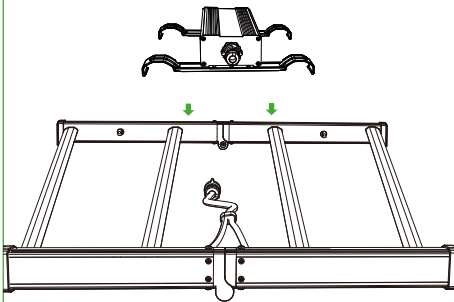

## STEP 3

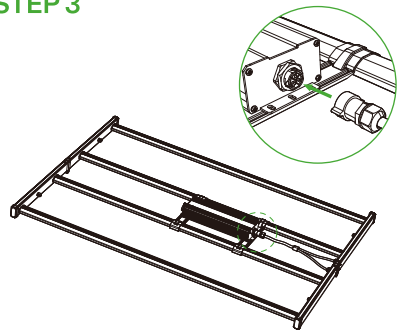

## STEP 4.A.1

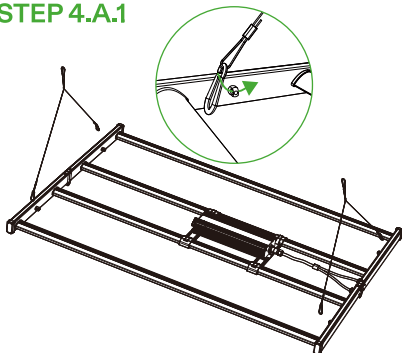

## STEP 4.A.2

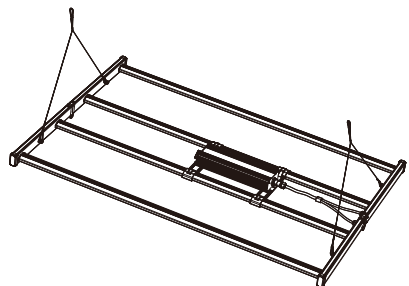

# INSTALLATION

## STEP 5

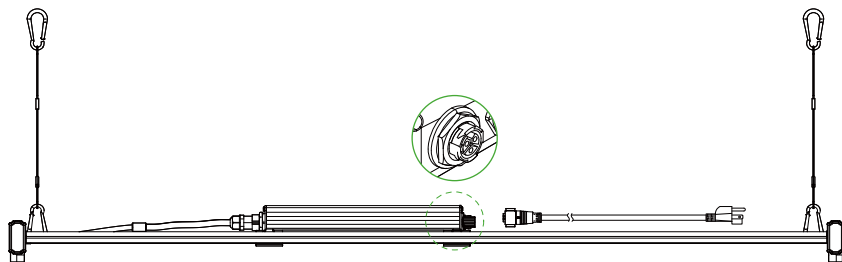

## STEP 6

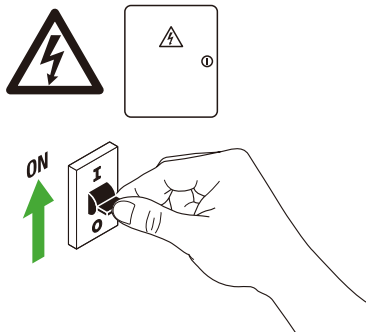

# CONNECT UP TO 160 LEDS

Set the knob to EXT

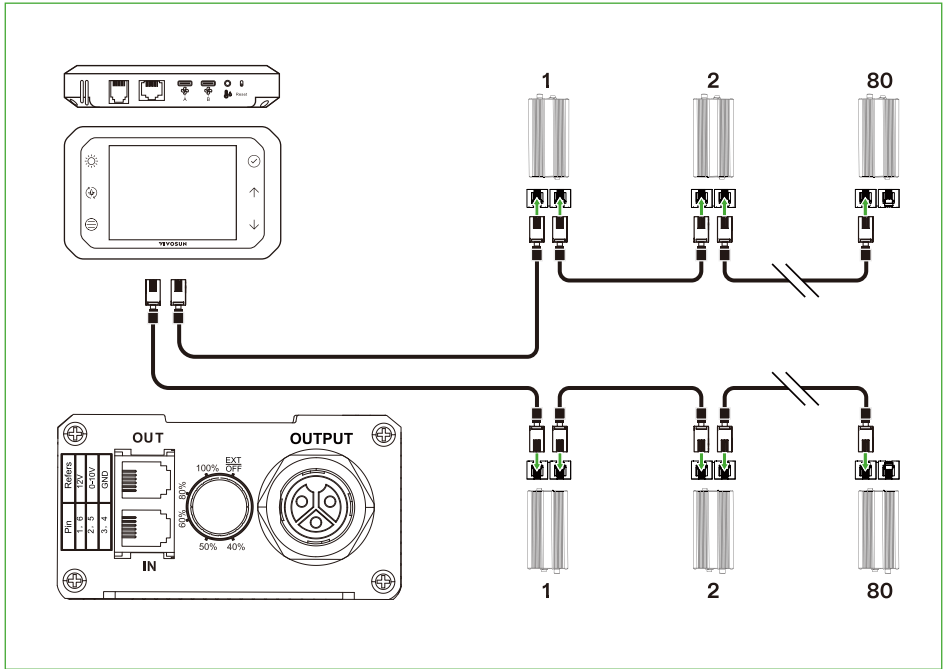

Designed by **YIVOSUN** in California.  
Made in China