

VIVOSUN



AeroZesh T

USER MANUAL

Love what you grow™

Welcome to **VIVOSUN**

Thank you for choosing VIVOSUN. We are committed to product quality and friendly customer service. If you have any questions or suggestions, please don't hesitate to contact us.

PRODUCTS INCLUDED IN THIS MANUAL:

Product	Model	SKU
AeroZesh T4	VSV-AZT4	VSV-AZT4
AeroZesh T6	VSV-AZT6	VSV-AZT6
AeroZesh T4 (E42A)	VSV-AZT4E42A	VSV-AZT4E42A
AeroZesh T6 (E42A)	VSV-AZT6E42A	VSV-AZT6E42A

CONTENTS

Safety Information	1
Key Features	2
Product Contents	3
Dimension	7
Specifications	8
Application	9
Installation	10
Fan Control.....	21
Maintenance	22
Complete Your Setup	23
Warranty Information.....	24

SAFETY INFORMATION

- Please read the manual carefully and follow the instructions before installing and operating the fan.
- The input voltage of this fan is 110Vac~240Vac. DO NOT use the fan under higher input voltages.
- The air transferred shall not be flammable, explosive, corrosive. The environment temperature shall not exceed 40°C.
- Direct spraying or cleaning by water or other liquid is forbidden. This may cause short circuit or electric shock.
- Installation on window or outdoor is forbidden.
- Avoiding air reflux via open air flue or other fired equipment.
- DO NOT use chemicals as gasoline, benzene and diluent to clean the fan.
- DO NOT let water into motor and electric parts, or make the plastic parts immerge into water with temperature higher than 60 °C.
- DO NOT cut off or reconnect the power cord. If the power cord is damaged, please contact us. Any unauthorized modifications will void the warranty immediately.

KEY FEATURES

QUIET PWM EC MOTOR

EC motor with PWM tuning provides low noise and energy saving.



DUAL BALL BEARINGS

Dual ball bearings in motor provide an estimated 67,000 hours lifespan. Enables the fan to be mounted in any direction.

1. Only on models of VSV-AZT4/VSV-AZT6.
2. Only on models of VSV-AZT4E42A/VSV-AZT6E42A.

EFFICIENT AIR FLOW

Efficient airflow delivery with hydro-mechanical stator blades in high static pressure.

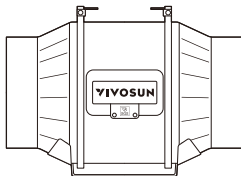

MULTIPLE MODES²

Manual, ON/OFF cycle, and intelligent Auto modes, quick and easy setup via the VIVOSUN GrowHub.

SPEED CONTROL & ON/OFF CYCLE¹

10-level speed control and three ON/OFF cycle modes via E12 controller.

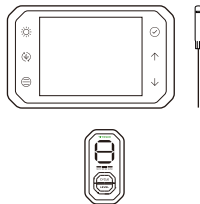

WI-FI & APP CONTROL²

Smart settings based on variable environment conditions via GrowHub and VIVOSUN App remotely.

PRODUCT CONTENTS

VSV-AZT4/VSV-AZT6

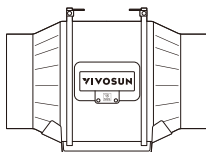

Duct Fan
x 1pc

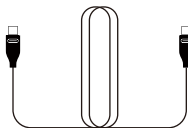

Type C Extension Cable
x 1pc



E12 Controller
x 1pc



Rope Hanger
x 2pcs

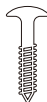

Screw Set
x 4pcs



Wall Anchor
x 4pcs

PRODUCT CONTENTS

VSV-AZT4E42A/VSV-AZT6E42A

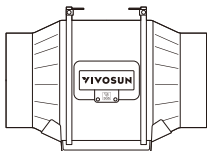

Duct Fan
x 1pc

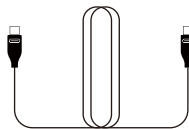

Type C Extension Cable
x 1pc



Rope Hanger
x 2pcs

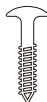

Screw Set
x 4pcs



Wall Anchor
x 4pcs

PRODUCT CONTENTS

VSV-AZT4E42A/VSV-AZT6E42A

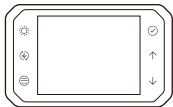

Smart Controller
x 1pc

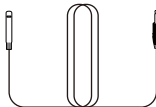

Temperature/ Humidity Sensor
(3m)



Expansion Screws
x 2pcs

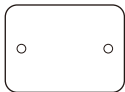

Iron Plate
x 1pc



Cable Tie
x 3pcs



Wire Tie
x 1pc

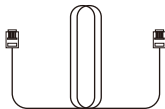

RJ11 Cable
(3m)

PRODUCT CONTENTS

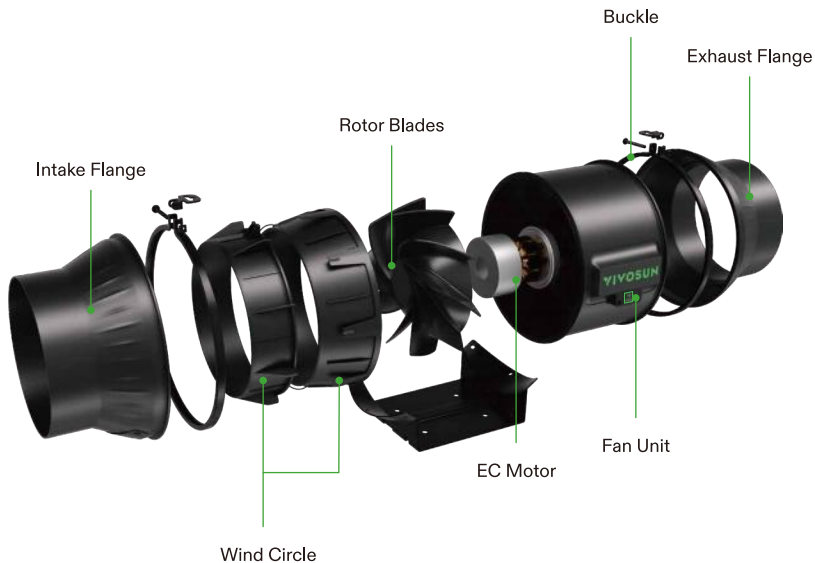

DIMENSION

Series No.	Part	Quantity
①	Flange	2
②	Fan Unit	1
③	Rotor Blades	1
④	Terminal Box	1
⑤	Buckle	2

Unit: mm

Model No.	VSV-AZT4	VSV-AZT6
A	302	313
ΦB	Φ97	Φ147
C	91	103
D	179	203
E	80	80
F	60	60
G Long hole	5,5x6,5	5,5x6,5
H	197	221
H1	100	111

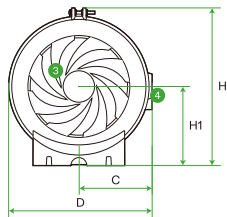
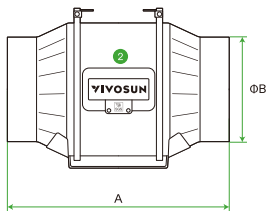
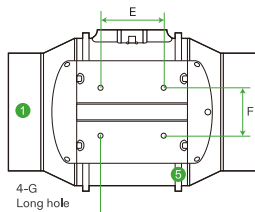

SPECIFICATIONS

	VSV-AZT4	VSV-AZT6
Size	4 inch	6 inch
Input	110-240VAC 50/60Hz	100-240VAC 50/60Hz
Average Power Usage	20W±5%	35W±5%
Airflow	210 CFM	408 CFM
Noise	35 dB(A)	37 dB(A)
Fan Speed (Max)	3000R/min±10%	3000R/min±10%
Electric Motor	EC-motor	EC-motor
Bearing	Ball Bearing NMB	Ball Bearing NMB
Bearing IP	IP44	IP44
Bearingsrated	67000 hrs	67000 hrs
Certification	FCC,CE	FCC,CE

APPLICATION

AeroZesh can be used as an exhaust fan or an intake fan for your grow space, and each has different setup position for optimal ventilation.

Exhaust fan: Hung or mounted on the highest opposite corner inside your grow space. Airflow arrow points away from your grow space.

Intake fan: Mounted at a bottom corner outside of your grow space. Airflow arrow points toward your grow space.

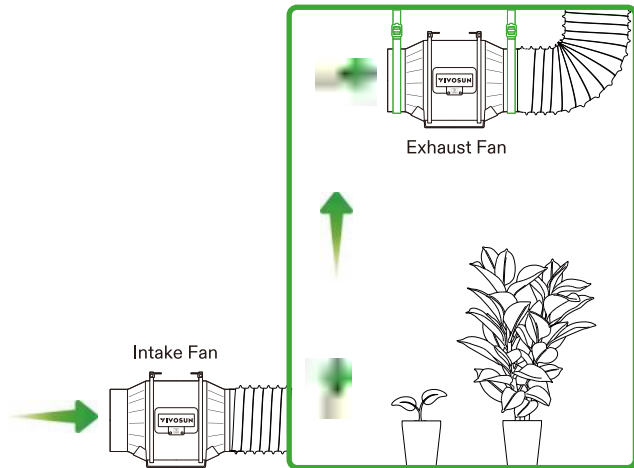

INSTALLATION

1. MOUNTING AS AN INTAKE FAN

STEP 1

Unscrew and loosen the buckles on the fan unit.

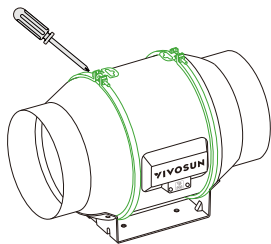

STEP 2

Remove the fan unit from the flange bracket.

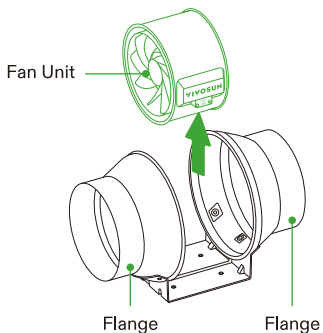

INSTALLATION

STEP 3

Drill four holes and fixed the two flange brackets on the desired position of a wood support or stud with four wood screws. For mounting on a surface other than wood, fix the wall anchors in the holes before screwing the wood screws to fix the flange brackets.

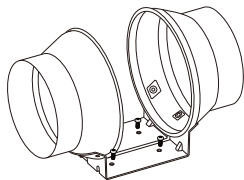

STEP 4

Slide the fan unit back between two flange brackets, make sure the airflow arrow on the fan unit is the same direction with that on the flange bracket. Then tighten the metal clamps to secure the fan unit.

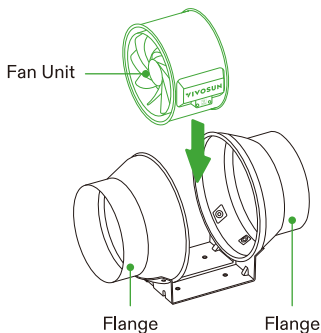

INSTALLATION

STEP 5

Put the buckles back on the fan unit and fix with screws.

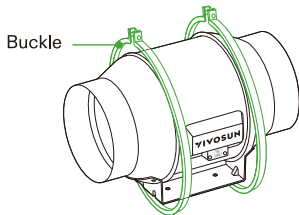

2. HANGING AS AN EXHAUST FAN

A. HANGING UPWARD

A.1 Hanging Straps

STEP 1

Loop the two hanging straps around the flanges as shown in the diagram.

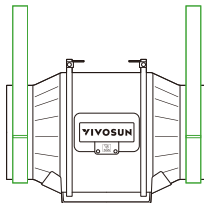

INSTALLATION

STEP 2

Slip the strap through the inner ladder lock slot from the bottom.

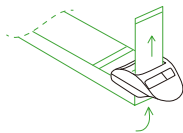

STEP 3

Pass the strap into the outer ladder lock slot from the top. Adjust the length of the completed loop as needed.

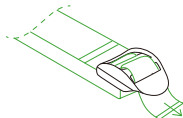
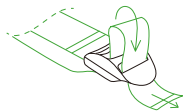

INSTALLATION

STEP 4

Tuck the loose end through the center gap of the ladder lock to secure the loop.

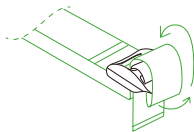

STEP 5

Loop the other end of two hanging straps around a pole as showed in picture.

Hang the fan by the duct flanges to secure it.

Adjust the height as needed to fit your space.

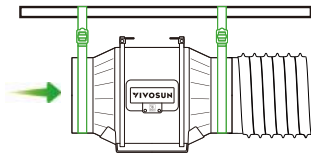

INSTALLATION

A.2 Rope Hangers (sold separately)

STEP 1

Loop the two rope hangers around the flanges as shown in the diagram. Lock the carabiners to the ropes to secure the fan.

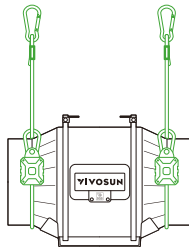

STEP 2

Loop the other end of the rope hangers around the crossbeam as shown in the diagram. Lock the carabiners to the rope to secure the fan to the pole.

Press the yellow adjustment button to raise and lower the fan to your desired height.

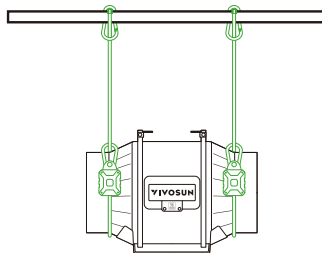

INSTALLATION

A.3 Rope Hangers

STEP 1

Thread the hook through the pole, as shown in the diagram.

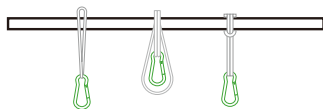

STEP 2

Lock the carabiners to the ropes to secure the fan to the pole.

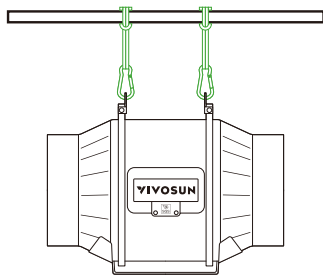

INSTALLATION

B. HANGING DOWNWARD

B.1 Hanging Straps

Loop the hanging straps around the pole and the flange brackets of the fan. Adjust and tighten the hanging straps, as show in part A.1, Steps 2-4. Let the fan hang on the pole once the straps are secure.

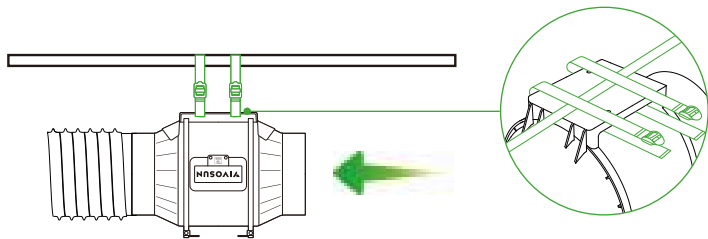

INSTALLATION

B.2 Rope Hangers(sold separately)

Loop the two rope hangers around the pole and the flange bracket of the fan. Secure the two hooks to their respective ropes to hang the fan.

Press the yellow button on the rope hanger to adjust the height of the fan to the desired level.

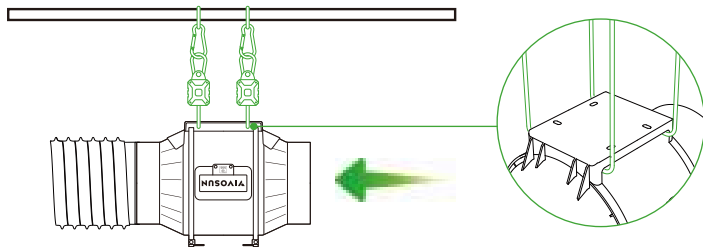

INSTALLATION

3. CONNECTING TO THE E12 CONTROLLER

VSV-AZT4/VSV-AZT6

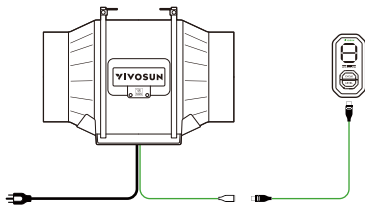

Use a Type-C extension cord to connect an AeroZesh to an E12 Controller. The controller will get power from the duct fan.

INSTALLATION

4. CONNECTING TO THE VIVOSUN GROWHUB CONTROLLER

VSV-AZT4E42A/VSV-AZT6E42A

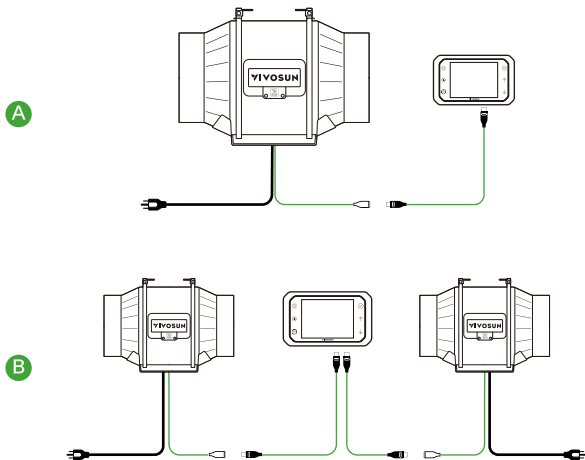

Use a Type-C extension cord to connect an AeroZesh to a GrowHub controller (A). A GrowHub controller has two Type-C ports to control two AeroZesh fans (B). The controller will get power from the AeroZesh.

FAN CONTROL

CONTROLLED BY E12 (VSV-AZT4/VSV-AZT6)

Fan Speed Setting

Press the "LEVEL" button to change the fan speed level from 0 to Max. The speed level will display above ("A" indicates the max speed level).

Long press "LEVEL" button for 3 seconds to quick turn off the duct fan. The speed level will be saved and restored if you turn on the duct fan by pressing the "LEVEL" button again.

ON/OFF Cycle Setting

Press the "CYCLE" button to switch between three ON/OFF cycle modes and the corresponding indicator light will on:

"50/10": 50min ON, 10min OFF

"30/30": 30min ON, 30min OFF. "10/50": 10min ON, 50min OFF. No lights on: Manual mode.

All the indicating lights and display screen will turn off after no operation for 10 seconds. Press any button to turn on the screen.

Notice: Suggest to use E12 outside the grow tent for longer life span.

CONTROLLED BY GROWHUB E42A (VSV-AZT4E42A/VSV-AZT6E42A)

Please see the manual of GrowHub E42A about duct fan control and App connection.

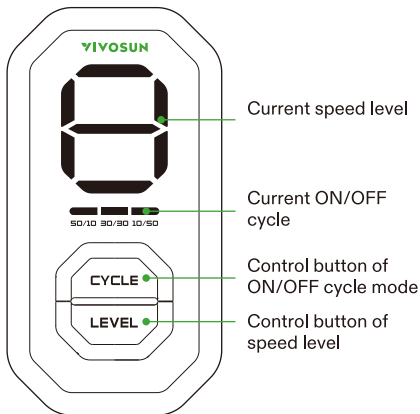

MAINTENANCE

Regular cleaning each year is suggested. **Make sure to turn off power before cleaning.**

STEP 1

Unscrew and loosen the buckles on the fan unit and remove it from the flange brackets.

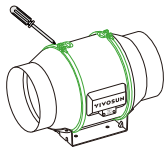

STEP 2

Use a damp cloth to clean the fan blades and the impeller.

Remove the wind circle in between the fan unit and intake flange. Clean the inside of intake and exhaust flanges and the wind circle.

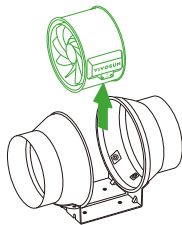

STEP 3

After cleaning, put the fan unit and wind circle back into the flange brackets and secure the buckles.

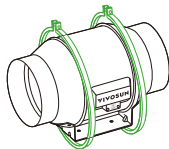

COMPLETE YOUR SETUP

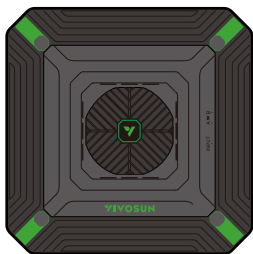

LED GROW LIGHT

AeroLight / VS / VSX / VSF

- 100W-645W powerful LED grow light
- High PPE efficacy with Samsung LED
- Full spectrum included FR / UV
- 0-100% dimming with daisy-chain
- ETL / CE / FCC certificated
- Compatible with GrowHub controller

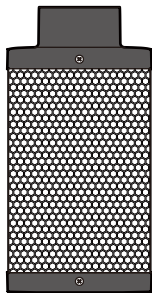

CARBON FILTER

- Eliminate odors and refresh air
- Premium grade of Australian charcoal
- High efficiency of absorption and long lifetime
- 4' / 6' / 8' compatible with different inline fans

WARRANTY INFORMATION

WARRANTY TERMS

1. We offer a 3-year warranty against manufacturing defects for all of our products from the date of purchase. If you need warranty assistance, please contact us as soon as possible.
2. The warranty does not cover damage due to high moisture levels, water damage, power surges, improper hanging/mounting, improper use, dust build-up, or users' unauthorized modifications.
3. In the USA, if any AeroZesh duct fan ceases working within 30 days of use, you can choose:
 - (A) Exchange: We will email you a pre-paid return label. Please ship the product back to our USA warranty center and a replacement will be sent to you free of charge as soon as we receive the defective product.
 - (B) Refund: We will email you a pre-paid return label. Please ship the product to our USA warranty center and we will issue a refund as soon as the product has been received. Refund periods may depend on the processing time of your bank or institution—usually, a refund takes about 5 business days to be processed.
4. Our company reserves all rights to the final explanation of this warranty structure. If you have any questions about our warranty policy, please contact us.

Designed by **VIVOSUN** in California.
Made in China